

NCP5181

High Voltage High and Low Side Driver

The NCP5181 is a High Voltage Power MOSFET Driver providing two outputs for direct drive of 2 N-channel power MOSFETs arranged in a half-bridge (or any other high-side + low-side) configuration.

It uses the bootstrap technique to insure a proper drive of the High-side power switch. The driver works with 2 independent inputs to accommodate any topology (including half-bridge, asymmetrical half-bridge, active clamp and full-bridge...).

Features

- High Voltage Range: up to 600 V
- dV/dt Immunity ± 50 V/nsec
- Gate Drive Supply Range from 10 V to 20 V
- High and Low DRV Outputs
- Output Source / Sink Current Capability 1.4 A / 2.2 A
- 3.3 V and 5 V Input Logic Compatible
- Up to V_{CC} Swing on Input Pins
- Matched Propagation Delays between Both Channels
- Outputs in Phase with the Inputs
- Independent Logic Inputs to Accommodate All Topologies
- Under V_{CC} LockOut (UVLO) for Both Channels
- Pin to Pin Compatible with IR2181(S)
- These are Pb-Free Devices

Applications

- High Power Energy Management
- Half-bridge Power Converters
- Any Complementary Drive Converters (asymmetrical half-bridge, active clamp)
- Full-bridge Converters
- Bridge Inverters for UPS Systems

PIN ASSIGNMENT

PIN	FUNCTION
IN_HI	Logic Input for High Side Driver Output In Phase
IN_LO	Logic Input for Low Side Driver Output In Phase
GND	Ground
DRV_LO	Low Side Gate Drive Output
V_{CC}	Low Side and Main Power Supply
V_{BOOT}	Bootstrap Power Supply
DRV_HI	High Side Gate Drive Output
BRIDGE	Bootstrap Return or High Side Floating Supply Return



ON Semiconductor[®]

<http://onsemi.com>

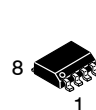
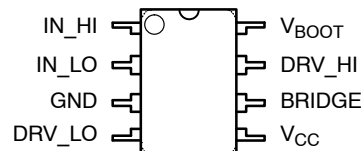

SOIC-8
D SUFFIX
CASE 751

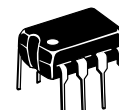

PDIP-8
P SUFFIX
CASE 626

MARKING DIAGRAMS

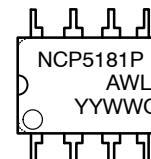
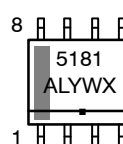

NCP5181P,
5181 = Specific Device Code
A = Assembly Location
L = Wafer Lot
Y, YY = Year
W, WW = Work Week
G or ■ = Pb-Free Package

ORDERING INFORMATION

Device	Package	Shipping [†]
NCP5181PG	PDIP-8 (Pb-Free)	50 Units/Tube
NCP5181DR2G	SOIC-8 (Pb-Free)	2,500/Tape & Reel

[†]For information on tape and reel specifications, including part orientation and tape sizes, please refer to our Tape and Reel Packaging Specification Brochure, BRD8011/D.

NCP5181

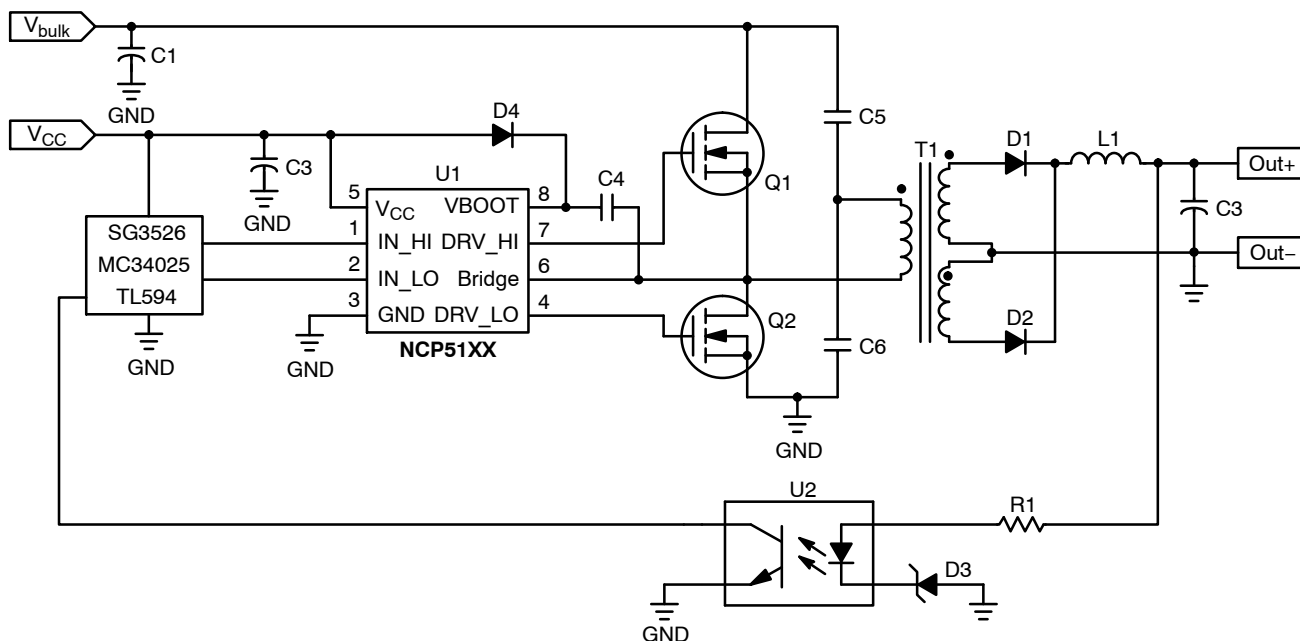

Figure 1. Typical Application

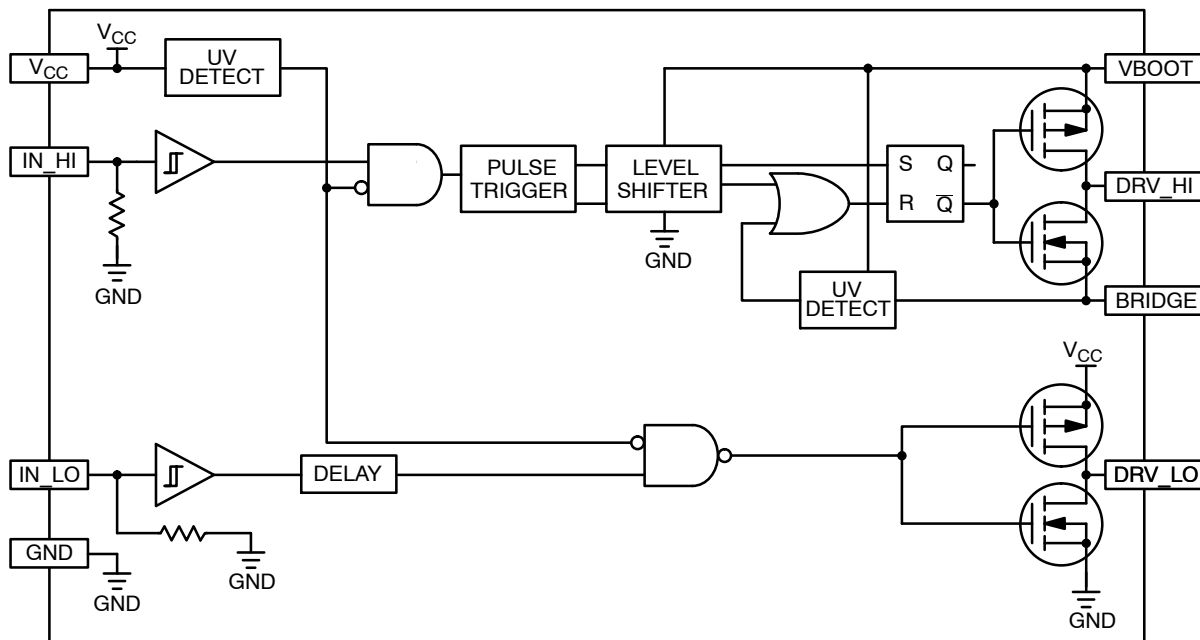

Figure 2. Detailed Block Diagram

NCP5181

MAXIMUM RATINGS

Rating	Symbol	Value	Unit
Main Power Supply Voltage	V_{CC}	-0.3 to 20	V
VHV: High Voltage BOOT Pin	V_{BOOT}	-1 to 620	V
VHV: High Voltage BRIDGE Pin	V_{BRIDGE}	-1 to 600	V
VHV: Floating Supply Voltage	$V_{BOOT} - V_{BRIDGE}$	0 to 20	V
VHV: High Side Output Voltage	V_{DRV_HI}	$V_{BRIDGE}-0.3$ to $V_{BOOT}+0.3$	V
Low Side Output Voltage	V_{DRV_LO}	-0.3 to $V_{CC}+0.3$	V
Allowable Output Slew Rate	dV_{BRIDGE}/dt	50	V/ns
Inputs IN_HI, IN_LO	V_{IN_XX}	-1.0 to $V_{CC}+0.3$	V
ESD Capability: Human Body Model (All Pins Except Pins 6-7-8) Machine Model (All Pins Except Pins 6-7-8)		2.0 200	kV V
Latchup Capability per Jedec JESD78			
Power Dissipation and Thermal Characteristics PDIP8: Thermal Resistance, Junction-to-Air SO-8: Thermal Resistance, Junction-to-Air	$R_{\theta JA}$ $R_{\theta JA}$	100 178	°C/W
Maximum Operating Junction Temperature	T_{J_max}	+150	°C

Stresses exceeding Maximum Ratings may damage the device. Maximum Ratings are stress ratings only. Functional operation above the Recommended Operating Conditions is not implied. Extended exposure to stresses above the Recommended Operating Conditions may affect device reliability.

NCP5181

ELECTRICAL CHARACTERISTICS ($V_{CC} = V_{boot} = 15\text{ V}$, $V_{gnd} = V_{bridge}$, $-40^{\circ}\text{C} < T_A < 125^{\circ}\text{C}$, Outputs loaded with 1 nF)

Rating	Symbol	$T_A -40^{\circ}\text{C to } 125^{\circ}\text{C}$			Units
--------	--------	---	--	--	-------

OUTPUT SECTION

		Min	Typ	Max	
Output High Short Circuit pulsed Current $V_{DRV} = 0\text{ V}$, $PW \leq 10\ \mu\text{s}$, (Note 1)	$I_{DRVhigh}$	-	1.4	-	A
Output Low Short Circuit Pulsed Current $V_{DRV} = V_{CC}$, $PW \leq 10\ \mu\text{s}$, (Note 1)	I_{DRVlow}	-	2.2	-	A
Output Resistor (Typical Value @ 25°C Only) Source	R_{OH}	-	5	12	Ω
Output Resistor (Typical Value @ 25°C Only) Sink	R_{OL}	-	2	8	Ω

DYNAMIC OUTPUT SECTION

Rating	Symbol	Min	Typ	Max	Units
Turn-on Propagation Delay ($V_{bridge} = 0\text{ V}$)	t_{ON}	-	100	170	ns
Turn-off Propagation Delay ($V_{bridge} = 0\text{ V}$ or 50 V) (Note 2)	t_{OFF}	-	100	170	ns
Output Voltage Risetime (from 10% to 90% @ $V_{CC} = 15\text{ V}$) with 1 nF Load	t_r	-	40	60	ns
Output Voltage Falling Edge (from 90% to 10% @ $V_{CC} = 15\text{ V}$) with 1 nF Load	t_f	-	20	40	ns
Propagation Delay Matching between the High Side and the Low Side @ 25°C (Note 3)	Δ_t	-	20	35	ns
Minimum Input Pulse Width that Changes the Output	t_{PW}	-	-	100	ns

INPUT SECTION

Low Level Input Voltage Threshold	V_{IN}	-	-	0.8	V
Input Pulldown Resistor ($V_{IN} < 0.5\text{ V}$)	R_{IN}	-	200	-	$k\Omega$
High Level Input Voltage Threshold	V_{IN}	2.3	-	-	V

SUPPLY SECTION

V_{CC} UV Startup Voltage Threshold	V_{CC_stup}	7.9	8.9	9.8	V
V_{CC} UV Shutdown Voltage Threshold	V_{CC_shdwn}	7.3	8.2	9.0	V
Hysteresis on V_{CC}	V_{CC_hyst}	0.3	0.7	-	V
V_{boot} Startup Voltage Threshold Reference to Bridge Pin ($V_{boot_stup} = V_{boot} - V_{bridge}$)	V_{boot_stup}	7.9	8.9	9.8	V
V_{boot} UV Shutdown Voltage Threshold	V_{boot_shdwn}	7.3	8.2	9.0	V
Hysteresis on V_{boot}	V_{boot_shdwn}	0.3	0.7	-	V
Leakage Current on High Voltage Pins to GND ($V_{BOOT} = V_{BRIDGE} = DRV_HI = 600\text{ V}$)	I_{HV_LEAK}	-	0.5	40	μA
Consumption in Active Mode ($V_{CC} = V_{boot}$, $f_{sw} = 100\text{ kHz}$ and 1 nF Load on Both Driver Outputs)	I_{CC1}	-	4.5	6.5	mA
Consumption in Inhibition Mode ($V_{CC} = V_{boot}$)	I_{CC2}	-	250	400	μA
V_{CC} Current Consumption in Inhibition Mode	I_{CC3}	-	215	-	μA
V_{boot} Current Consumption in Inhibition Mode	I_{CC4}	-	35	-	μA

*Note: see also characterization curves

1. Guaranteed by design.
2. Turn-off propagation delay @ $V_{bridge} = 600\text{ V}$ is guaranteed by design
3. See characterization curve for Δ_t parameters variation on the full range temperature.
4. Timing diagram definition see Figures 4, 5 and 6.

NCP5181

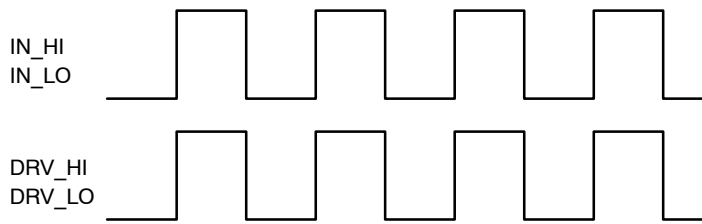

Figure 3. Input/Output Timing Diagram

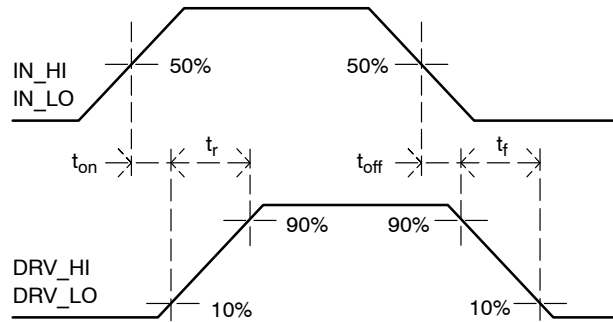

Figure 4. Switching Time Waveform Definitions

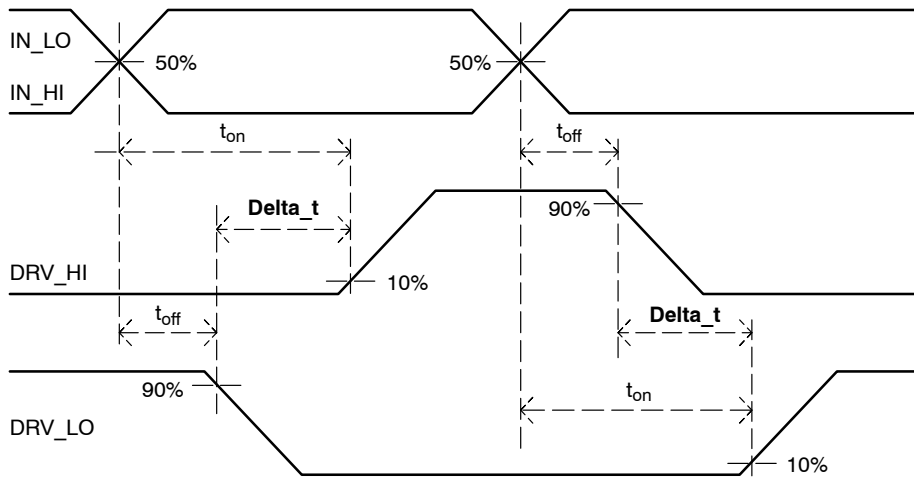

Figure 5. Delay Matching Waveforms Definition

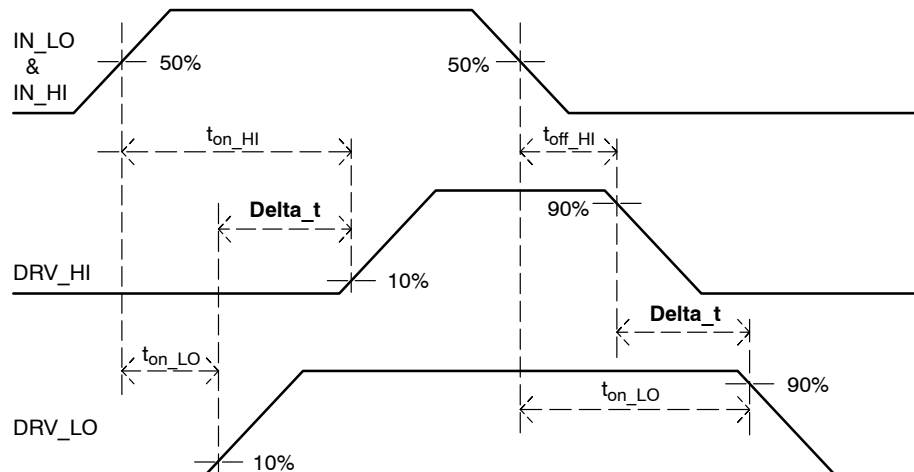

Figure 6. Other Delay Matching Waveforms Definition

TYPICAL CHARACTERISTICS

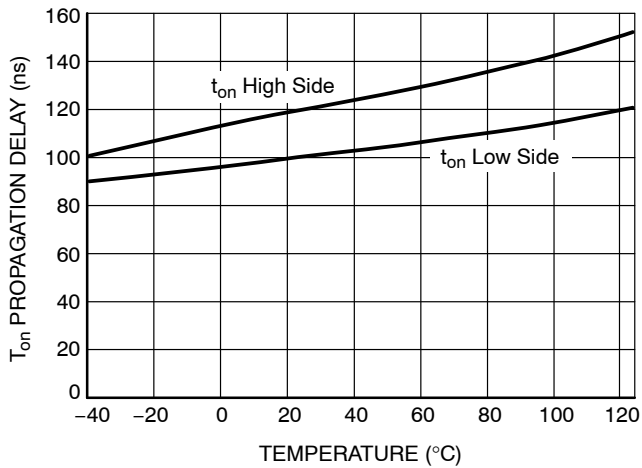

Figure 7. Turn-on Propagation Delay vs. Temperature

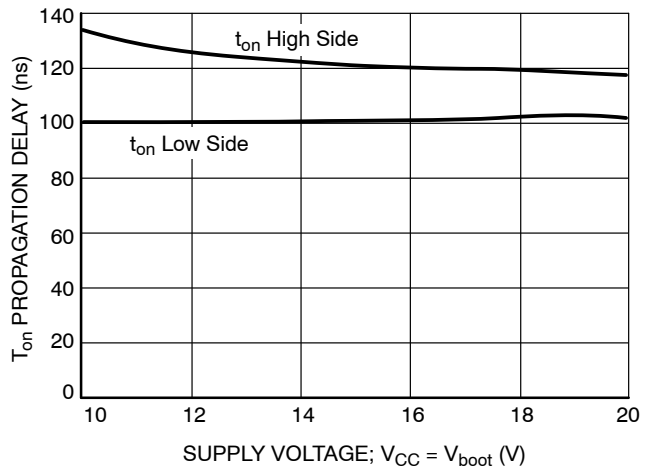

Figure 8. Turn-on Propagation Delay vs. V_{CC} Voltage (V_{CC} = V_{boot})

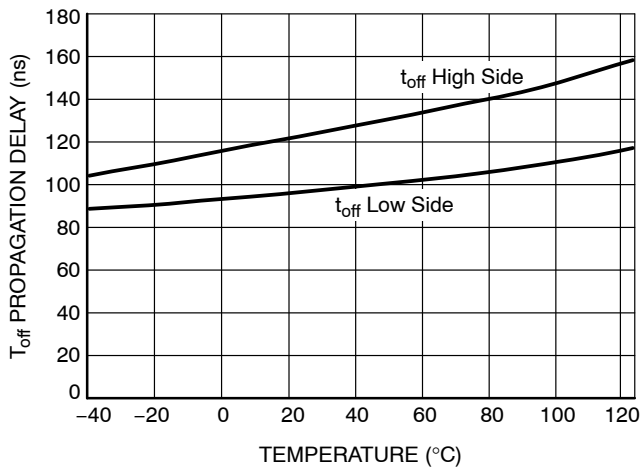

Figure 9. Turn-off Propagation Delay vs. Temperature

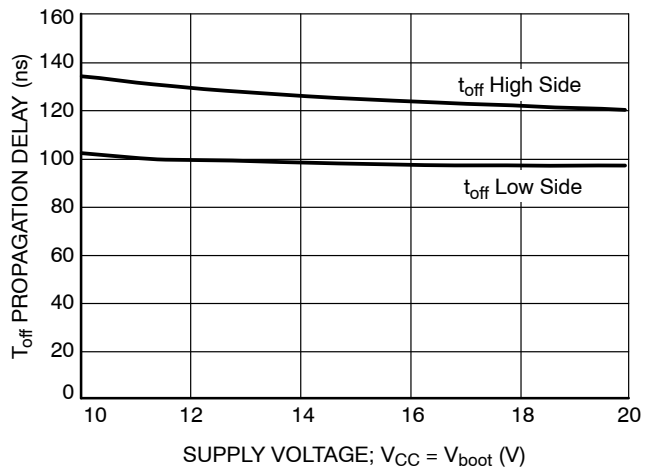

Figure 10. Turn-off Propagation Delay vs. V_{CC} Voltage (V_{CC} = V_{boot})

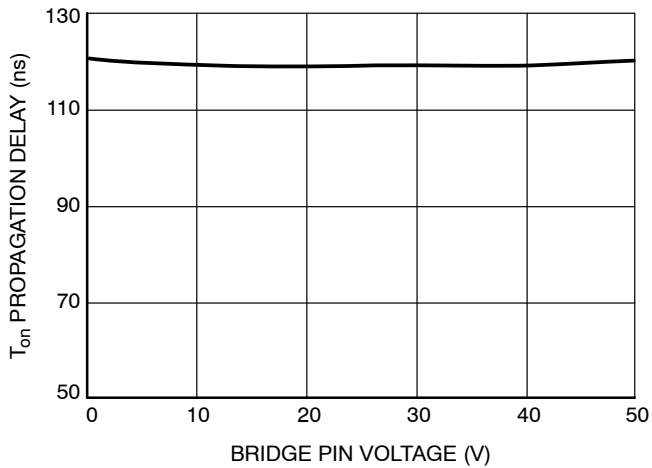

Figure 11. High Side Turn-on Propagation Delay vs. V_{BRIDGE} Voltage

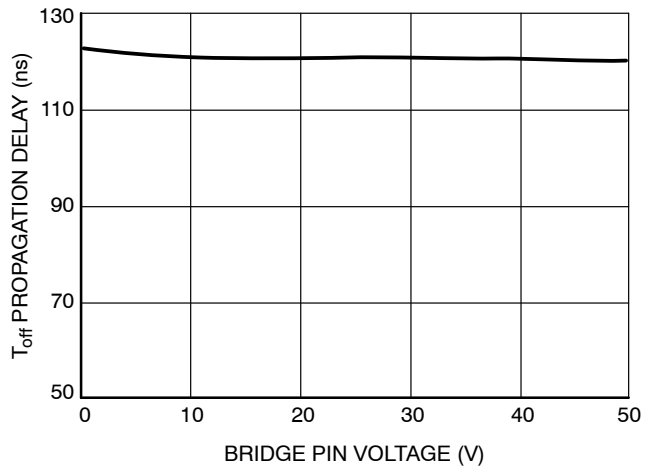

Figure 12. High Side Turn-off Propagation Delay vs. V_{BRIDGE} Voltage

TYPICAL CHARACTERISTICS

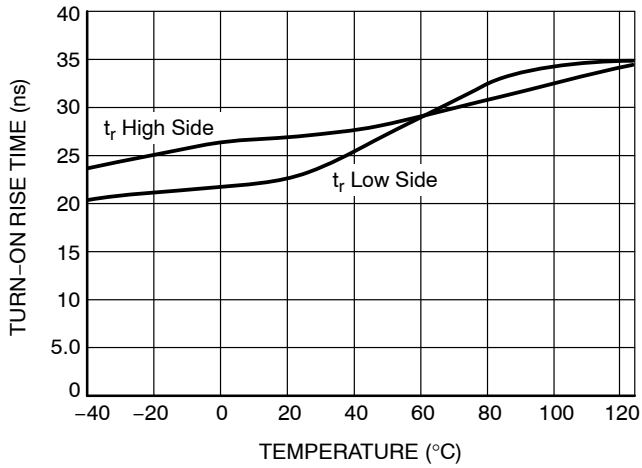

Figure 13. Turn-on Rise Time vs. Temperature

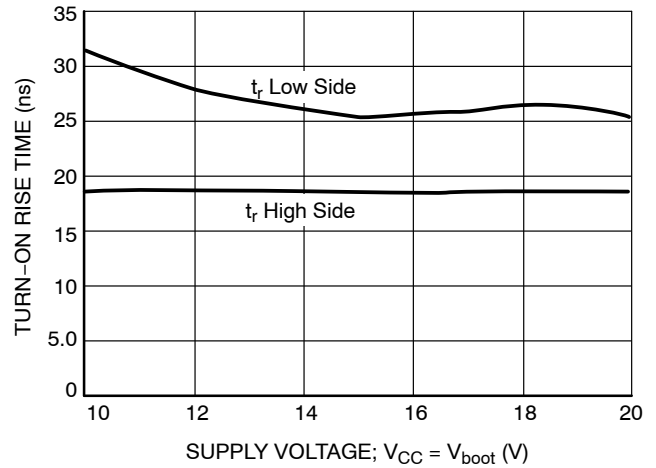

Figure 14. Turn-on Rise Time vs. V_{CC} Voltage ($V_{CC} = V_{boot}$)

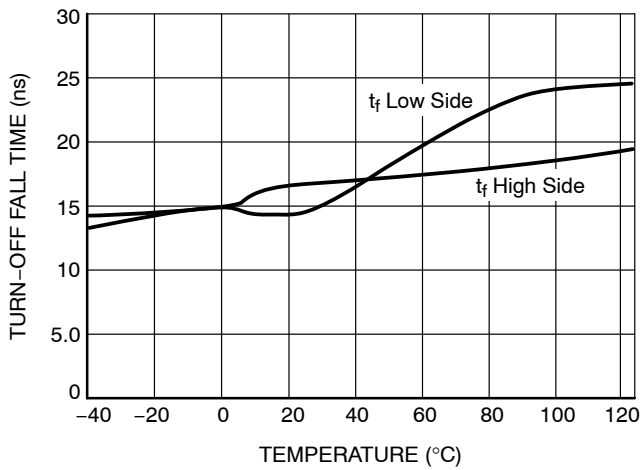

Figure 15. Turn-off Fall Time vs. Temperature

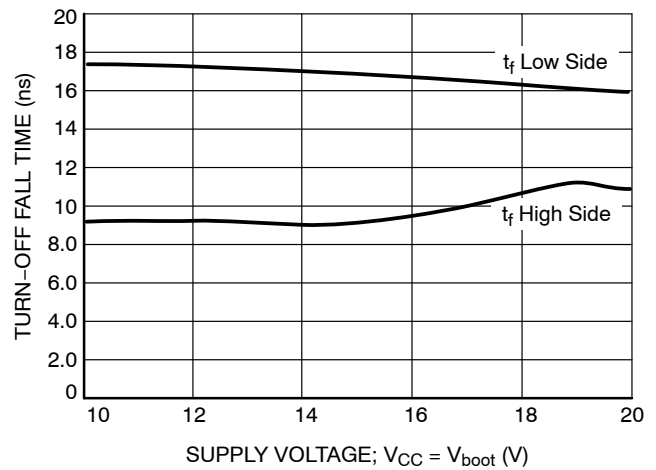

Figure 16. Turn-off Fall Time vs. V_{CC} Voltage ($V_{CC} = V_{boot}$)

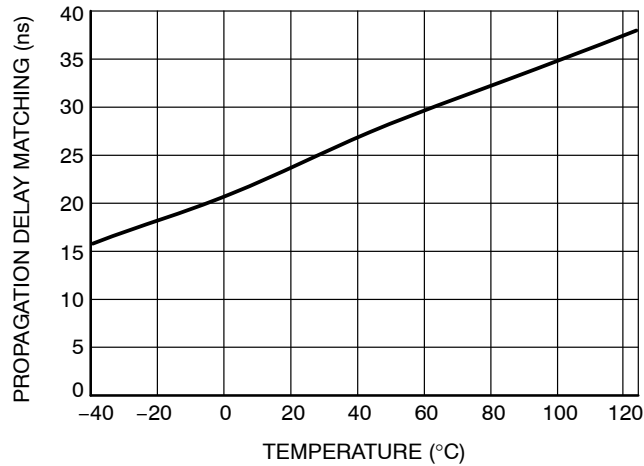

Figure 17. Propagation Delay Matching Between High Side and Low Side Driver

TYPICAL CHARACTERISTICS

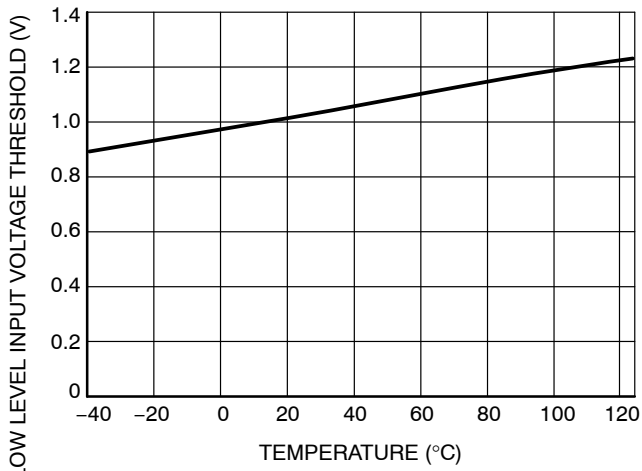

Figure 18. Low Level Input Voltage Threshold vs. Temperature

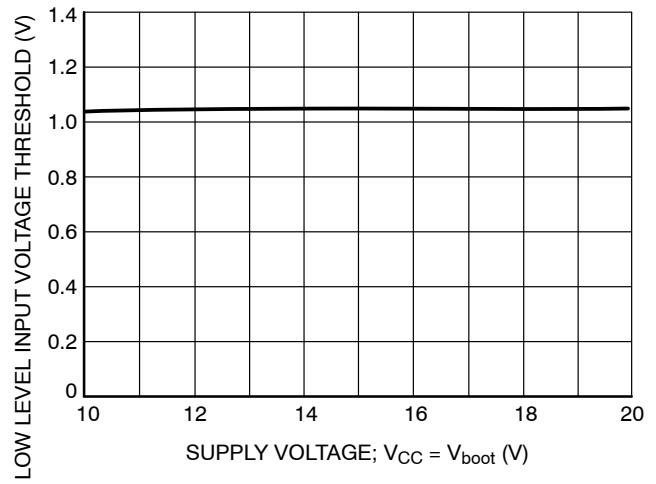

Figure 19. Low Level Input Voltage Threshold vs. V_{CC} Voltage

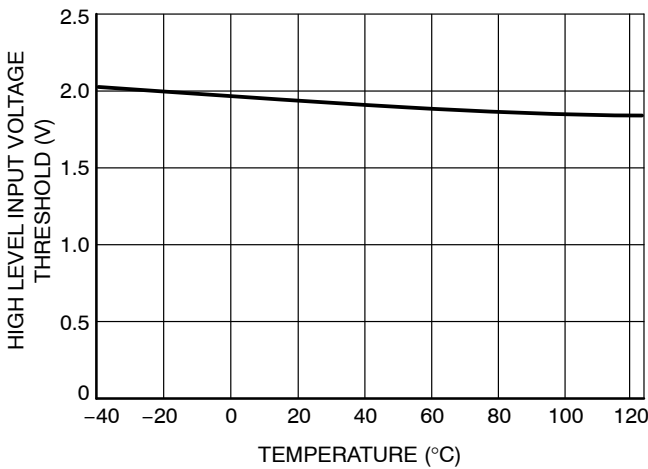

Figure 20. High Level Input Voltage Threshold vs. Temperature

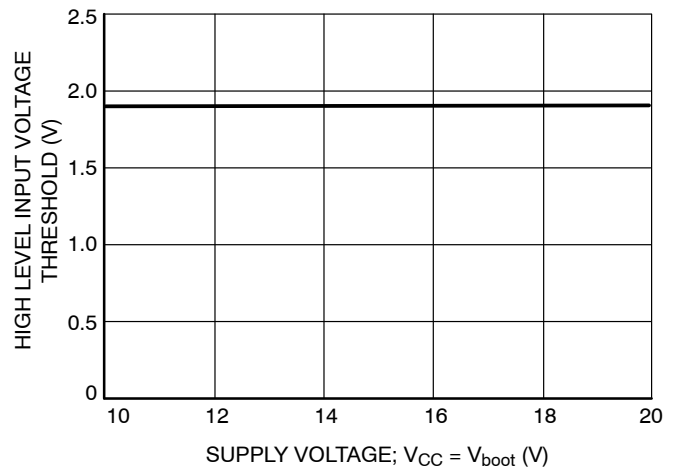

Figure 21. High Level Input Voltage Threshold vs. V_{CC} Voltage

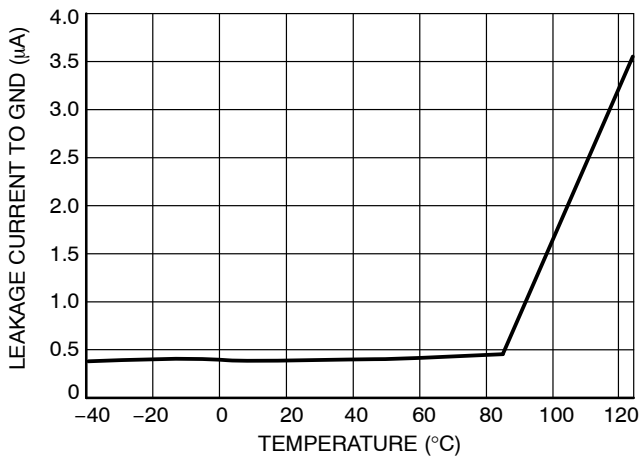

Figure 22. Leakage Current on High Voltage Pins (600 V) to Ground vs. Temperature

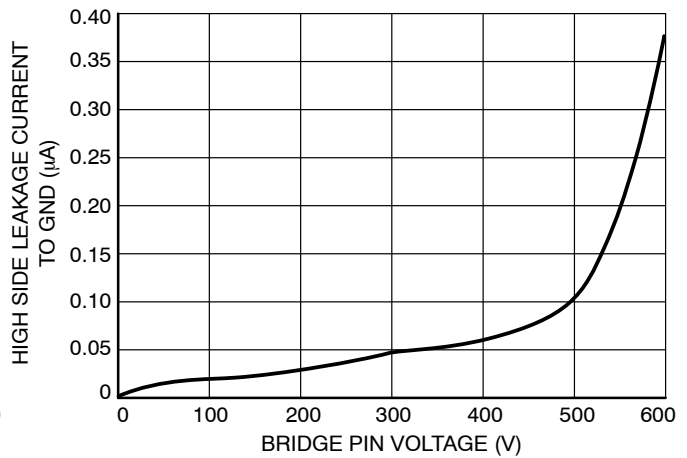

Figure 23. Leakage Current on High Voltage Pins to Ground vs. V_{bridge} Voltage (V_{bridge} = V_{boot} = V_{DRV_HI})

TYPICAL CHARACTERISTICS

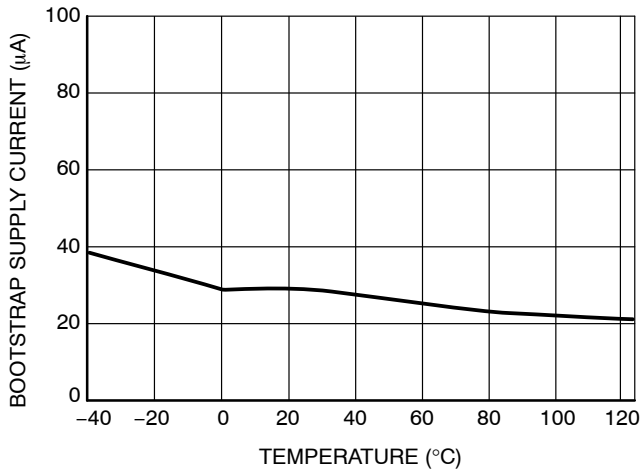

Figure 24. High Side Supply Current vs. Temperature

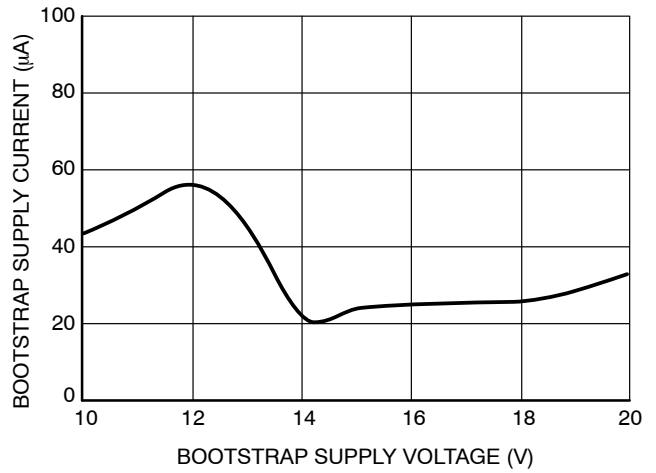

Figure 25. High Side Supply Current vs. Bootstrap Supply Voltage

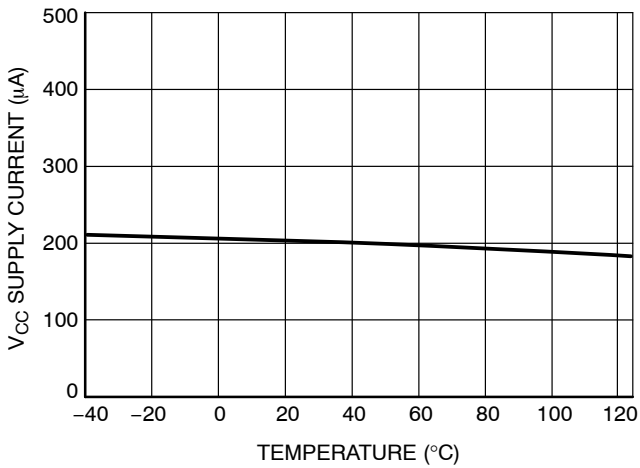

Figure 26. V_{CC} Supply Current vs. Temperature

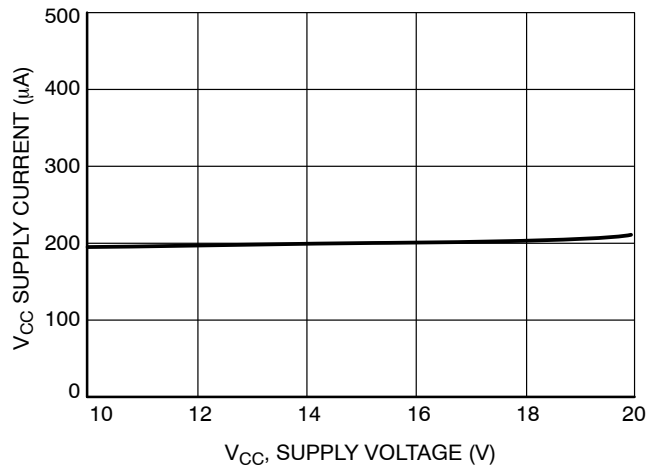

Figure 27. V_{CC} Supply Current vs. V_{CC} Supply Voltage

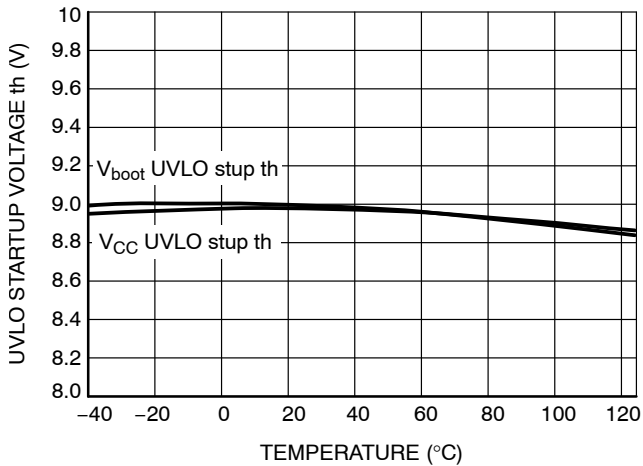

Figure 28. UVLO Start Up Voltage vs. Temperature

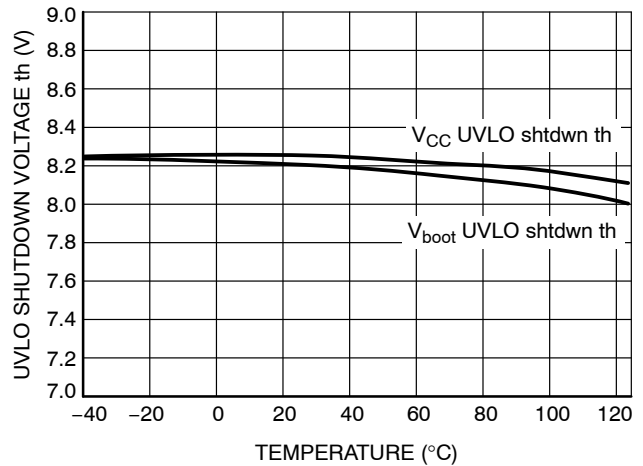

Figure 29. UVLO Shut Down Voltage vs. Bootstrap Supply Voltage

TYPICAL CHARACTERISTICS

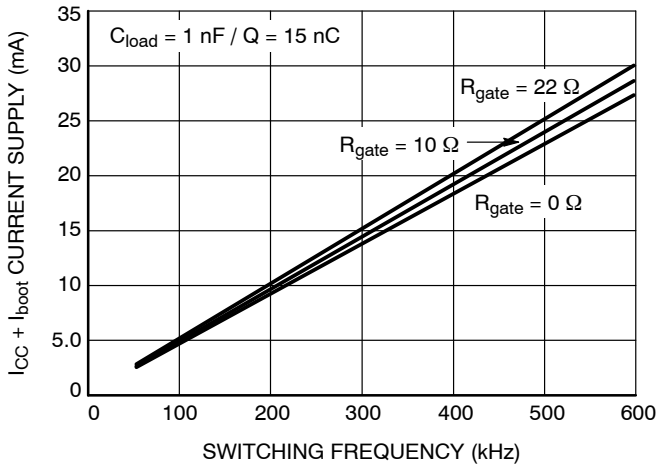

Figure 30. ICC1 Consumption vs. Switching Frequency with 15 nC Load on Each Driver

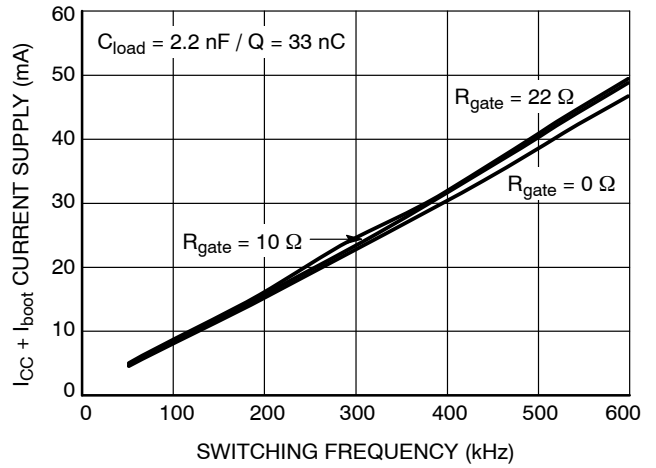

Figure 31. ICC1 Consumption vs. Switching Frequency with 33 nC Load on Each Driver

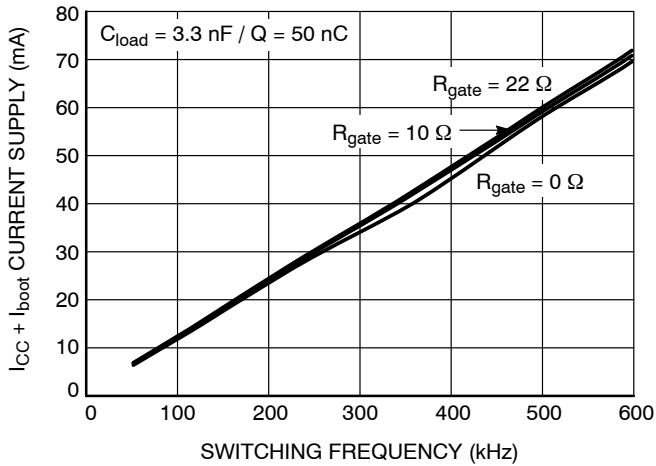

Figure 32. ICC1 Consumption vs. Switching Frequency with 50 nC Load on Each Driver

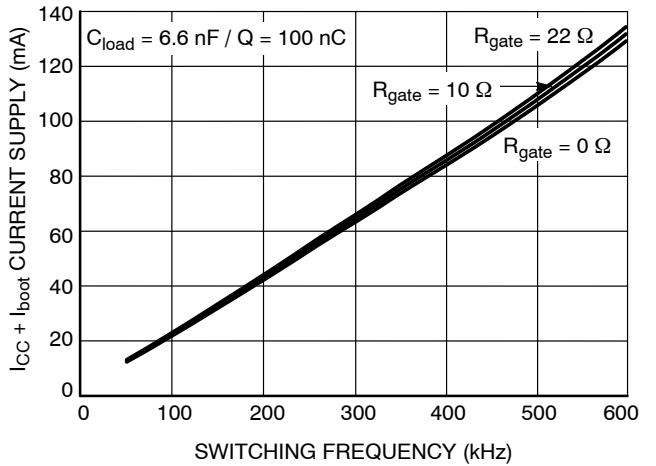
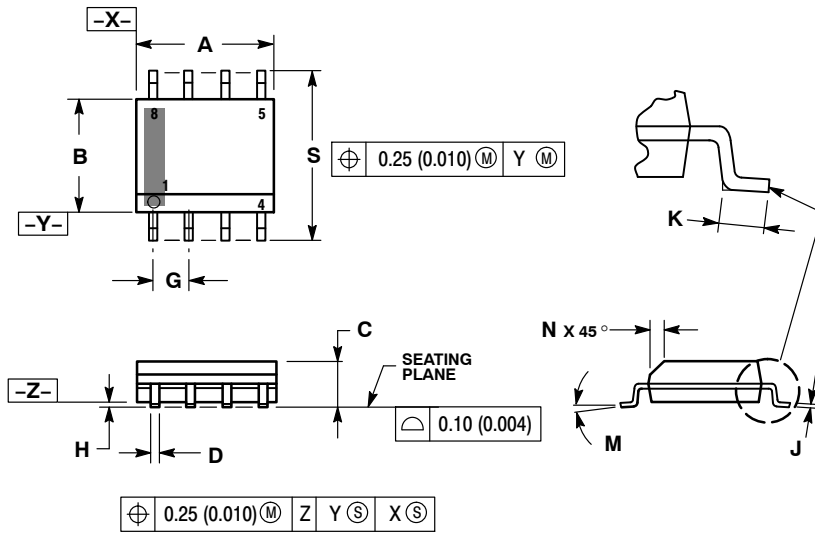

Figure 33. ICC1 Consumption vs. Switching Frequency with 100 nC Load on Each Driver

NCP5181

PACKAGE DIMENSIONS

SOIC-8 NB
CASE 751-07
ISSUE AH



NOTES:

1. DIMENSIONING AND TOLERANCING PER ANSI Y14.5M, 1982.
2. CONTROLLING DIMENSION: MILLIMETER.
3. DIMENSION A AND B DO NOT INCLUDE MOLD PROTRUSION.
4. MAXIMUM MOLD PROTRUSION 0.15 (0.006) PER SIDE.
5. DIMENSION D DOES NOT INCLUDE DAMBAR PROTRUSION. ALLOWABLE DAMBAR PROTRUSION SHALL BE 0.127 (0.005) TOTAL IN EXCESS OF THE D DIMENSION AT MAXIMUM MATERIAL CONDITION.
6. 751-01 THRU 751-06 ARE OBSOLETE. NEW STANDARD IS 751-07.

DIM	MILLIMETERS		INCHES	
	MIN	MAX	MIN	MAX
A	4.80	5.00	0.189	0.197
B	3.80	4.00	0.150	0.157
C	1.35	1.75	0.053	0.069
D	0.33	0.51	0.013	0.020
G	1.27 BSC		0.050 BSC	
H	0.10	0.25	0.004	0.010
J	0.19	0.25	0.007	0.010
K	0.40	1.27	0.016	0.050
M	0°	8°	0°	8°
N	0.25	0.50	0.010	0.020
S	5.80	6.20	0.228	0.244

SOLDERING FOOTPRINT*

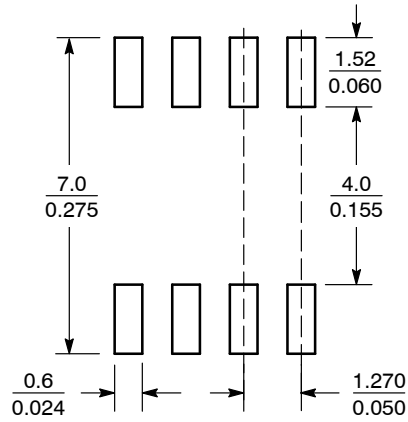

SCALE 6:1 (mm/inches)

*For additional information on our Pb-Free strategy and soldering details, please download the ON Semiconductor Soldering and Mounting Techniques Reference Manual, SOLDERRM/D.

NCP5181

PACKAGE DIMENSIONS

8 LEAD PDIP
CASE 626-05
ISSUE L

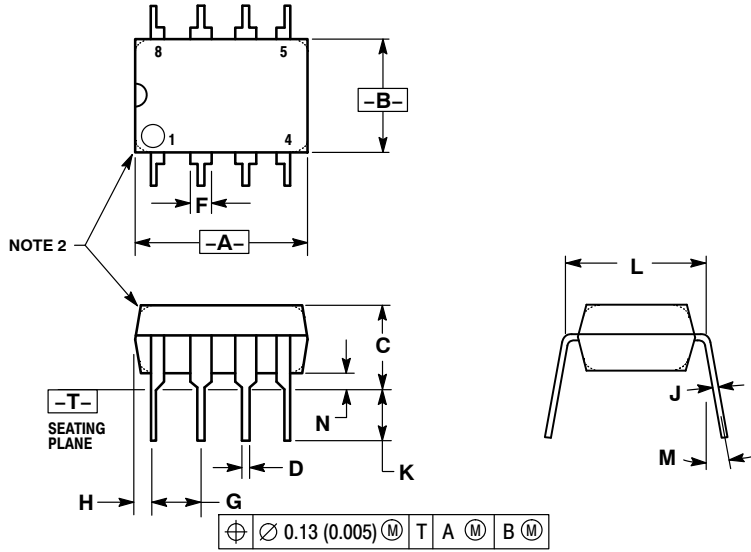

NOTES:

1. DIMENSION L TO CENTER OF LEAD WHEN FORMED PARALLEL.
2. PACKAGE CONTOUR OPTIONAL (ROUND OR SQUARE CORNERS).
3. DIMENSIONING AND TOLERANCING PER ANSI Y14.5M, 1982.

DIM	MILLIMETERS		INCHES	
	MIN	MAX	MIN	MAX
A	9.40	10.16	0.370	0.400
B	6.10	6.60	0.240	0.260
C	3.94	4.45	0.155	0.175
D	0.38	0.51	0.015	0.020
F	1.02	1.78	0.040	0.070
G	2.54 BSC		0.100 BSC	
H	0.76	1.27	0.030	0.050
J	0.20	0.30	0.008	0.012
K	2.92	3.43	0.115	0.135
L	7.62 BSC		0.300 BSC	
M	---	10°	---	10°
N	0.76	1.01	0.030	0.040

The product described herein (NCP5181), is covered by U.S. patent: 6,362, 067. There may be some other patent pending.

ON Semiconductor and are registered trademarks of Semiconductor Components Industries, LLC (SCILLC). SCILLC reserves the right to make changes without further notice to any products herein. SCILLC makes no warranty, representation or guarantee regarding the suitability of its products for any particular purpose, nor does SCILLC assume any liability arising out of the application or use of any product or circuit, and specifically disclaims any and all liability, including without limitation special, consequential or incidental damages. "Typical" parameters which may be provided in SCILLC data sheets and/or specifications can and do vary in different applications and actual performance may vary over time. All operating parameters, including "Typicals" must be validated for each customer application by customer's technical experts. SCILLC does not convey any license under its patent rights nor the rights of others. SCILLC products are not designed, intended, or authorized for use as components in systems intended for surgical implant into the body, or other applications intended to support or sustain life, or for any other application in which the failure of the SCILLC product could create a situation where personal injury or death may occur. Should Buyer purchase or use SCILLC products for any such unintended or unauthorized application, Buyer shall indemnify and hold SCILLC and its officers, employees, subsidiaries, affiliates, and distributors harmless against all claims, costs, damages, and expenses, and reasonable attorney fees arising out of, directly or indirectly, any claim of personal injury or death associated with such unintended or unauthorized use, even if such claim alleges that SCILLC was negligent regarding the design or manufacture of the part. SCILLC is an Equal Opportunity/Affirmative Action Employer. This literature is subject to all applicable copyright laws and is not for resale in any manner.

PUBLICATION ORDERING INFORMATION

LITERATURE FULFILLMENT:
Literature Distribution Center for ON Semiconductor
P.O. Box 5163, Denver, Colorado 80217 USA
Phone: 303-675-2175 or 800-344-3860 Toll Free USA/Canada
Fax: 303-675-2176 or 800-344-3867 Toll Free USA/Canada
Email: orderlit@onsemi.com

N. American Technical Support: 800-282-9855 Toll Free USA/Canada
Europe, Middle East and Africa Technical Support:
Phone: 421 33 790 2910
Japan Customer Focus Center
Phone: 81-3-5773-3850

ON Semiconductor Website: www.onsemi.com
Order Literature: <http://www.onsemi.com/orderlit>
For additional information, please contact your local Sales Representative